

HydroTap by Zip Water

Residential Brochure



FILTERED | INSTANT | **BOILING** | CHILLED | SPARKLING



POWERED BY
G5
TECHNOLOGY

Experience water at its best



Featured Product Celsius All-in-One in Brushed Gold

“Best appliance in our house! This will save us countless hours, headaches and money! No more 30-pack plastic water bottles. No more boiling water for oatmeal and now we get sparkling water with a quick tap. This will make any kitchen an elegant kitchen!”

FILLIP HORD, OWNER AND CO-CEO OF HORDERLY PROFESSIONAL ORGANIZING



Classic Plus



Cube



Touch-Free Wave

Introduction	03
Celsius All-in-One	05
Arc	06
Cube	07
Classic Plus	08
Elite Plus	09
Touch-Free Wave	10
Maintenance & Warranty	11
Technical Information	12
Installation Requirements	13



Arc



Celsius All-in-One



Elite Plus



POWERED BY
G5
TECHNOLOGY

This is **not** just a faucet

The HydroTap by Zip Water is not just a faucet. With advanced filtration and instant access to filtered boiling, chilled and sparkling water, plus unfiltered hot & cold water, the HydroTap by Zip Water is:



Instant Boiling

Cooking made easy



Instant Chilled

Stylish sustainability



Instant Sparkling

Sparkling on demand

75 years of innovation

Founded in Australia in 1947, Zip Water has a rich history of innovation. After decades of advancing and perfecting our drinking water systems globally, we're thrilled to finally bring the HydroTap system to North America!

See why we are leading the way in performance and functionality:

MicroPurity™ filtration

Built-in 0.2 micron filter certified to NSF standards provides pure-tasting, filtered water for you and your family.



Air-cooled system

Our unique air-cooled refrigeration system is 100% water efficient.



PowerPulse technology

Our innovative Zip PowerPulse technology maintains stored boiling water to within 1-2° of your set temperature, meaning no energy or time is wasted waiting for water to boil.



Auto-diagnostics

An advanced auto-diagnostics system continuously monitors your HydroTap's performance.



Unique safety features

Our HydroTap systems are designed to deliver boiling water smoothly to minimize splashing. Additionally, our taps include a safety lock that must be activated before dispensing boiling water.



Smart customization

Our newly optimized menu in the G5 HydroTap command center allows you to select energy modes and usage settings for easier customization.



Fashioned for form and function

From pure-tasting, filtered boiling, chilled or sparkling water to unfiltered hot & cold water, the HydroTap by Zip Water dispenses water the way you want it. Combining eye-catching tap design with cutting-edge, under-counter technology, this revolutionary drinking water system isn't just an appliance. It's the new standard in hydration for today's trend-defining homes.



Instant Boiling

Cooking
made easy



Instant Chilled

Stylish
sustainability



Instant Sparkling

Sparkling
on demand

Sleek and stylish options



Celsius All-In-One

Arc

Cube

Classic Plus

Elite Plus

Touch-Free Wave

Ultra-modern. Boho-chic. Contemporary classic. Whatever your taste, there's a HydroTap to match, with a stunning selection of tap styles, finishes and dispensing options to choose from!



CHROME



BRUSHED
CHROME



MATTE
BLACK



BRUSHED
GOLD



POLISHED
NICKEL



BRUSHED
NICKEL



GUNMETAL

Celsius All-In-One

Featured product
HydroTap Celsius All-in-One in Matte Black
installed over the sink

The ultimate in functionality, the Celsius All-In-One is fitted over your sink and offers all five water types – filtered boiling, chilled and sparkling drinking water, plus unfiltered hot & cold water – from a single tap. And it's all wrapped up in Zip Water's enduringly stylish design.



*This product needs a hot and cold water supply

Available water options & finishes:

FILTERED:	UNFILTERED:
<p>BOILING</p> <p>CHILLED</p> <p>SPARKLING</p>	<p>HOT & COLD</p>

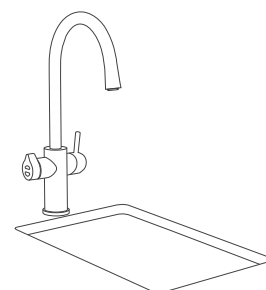
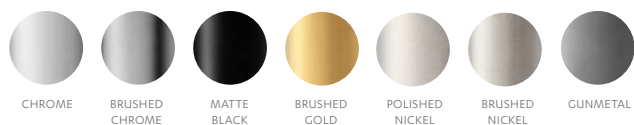

The HydroTap Celsius All-in-One should be installed over the sink as the primary faucet.

Arc







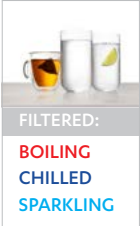
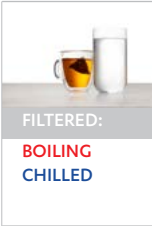
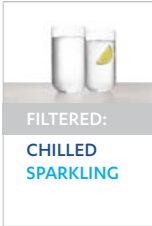

Featured product

HydroTap Arc in Brushed Gold installed over the sink as the secondary tap

Timeless and enduringly classic, the HydroTap Arc is an elegant choice. With its curved 'swan neck', it will complement any kitchen – from traditional to contemporary.



Available water options & finishes:

 <p>FILTERED: BOILING CHILLED SPARKLING</p>	 <p>FILTERED: BOILING CHILLED</p>	 <p>FILTERED: CHILLED SPARKLING</p>				
 <p>CHROME</p>	 <p>BRUSHED CHROME</p>	 <p>MATTE BLACK</p>	 <p>BRUSHED GOLD</p>	 <p>POLISHED NICKEL</p>	 <p>BRUSHED NICKEL</p>	 <p>GUNMETAL</p>

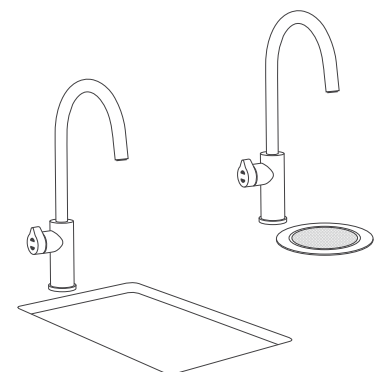

The HydroTap Arc tap can be installed over the sink as a secondary tap or on an optional font.

Cube

Featured product
HydroTap Cube in Chrome
installed with optional design font

For a truly contemporary twist on a classic, the HydroTap Cube is a modern kitchen's dream. A design statement in its own right, the angular Cube echoes a square shape, which is softened by its rounded corners.



Available water options & finishes:

 <p>FILTERED: BOILING CHILLED SPARKLING</p>	 <p>FILTERED: BOILING CHILLED</p>	 <p>FILTERED: CHILLED SPARKLING</p>				
 <p>CHROME</p>	 <p>BRUSHED CHROME</p>	 <p>MATTE BLACK</p>	 <p>BRUSHED GOLD</p>	 <p>POLISHED NICKEL</p>	 <p>BRUSHED NICKEL</p>	 <p>GUNMETAL</p>

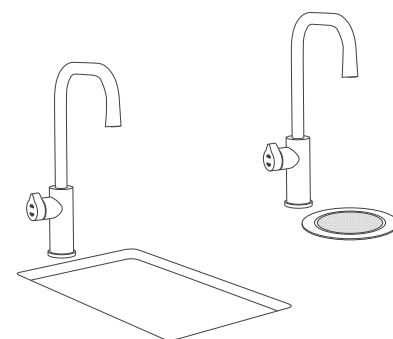

The HydroTap Cube tap can be installed over the sink as a secondary tap or on an optional font.

Classic Plus

Featured product

HydroTap Classic Plus in Chrome
installed with optional design font

The Classic Plus pairs iconic design with an intuitive touchpad making it the perfect complement to any kitchen or wet bar.



Available water options & finishes:

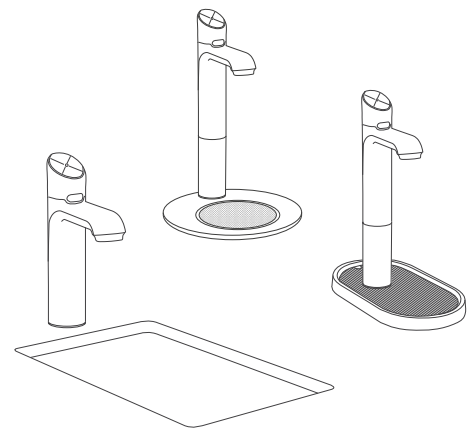
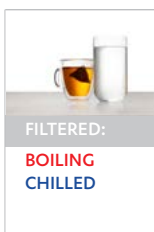
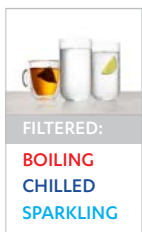

The Classic Plus tap can be installed over the sink as a secondary tap or on an optional font.

*The Classic Plus Tap is not available in polished nickel.

Elite Plus



Featured product

HydroTap Elite Plus in Gunmetal
installed over the sink as the secondary tap

If minimalist and understated is more your style in the heart of the home, the streamlined design and clean lines of the HydroTap Elite Plus are sure to please.



Available water options & finishes:

 <p>FILTERED: BOILING CHILLED SPARKLING</p>	 <p>FILTERED: BOILING CHILLED</p>	 <p>FILTERED: CHILLED SPARKLING</p>
---	--	--

					
CHROME	BRUSHED CHROME	MATTE BLACK	BRUSHED GOLD	BRUSHED NICKEL	GUNMETAL

*The Elite Plus Tap is not available in polished nickel.

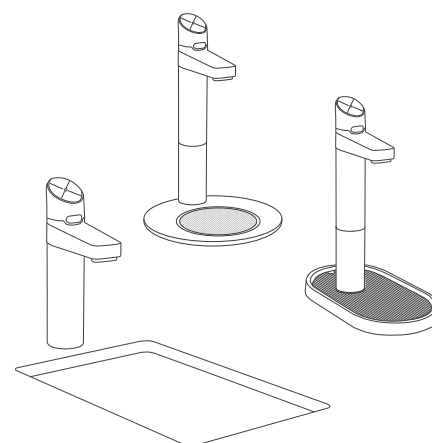

The Elite Plus tap can be installed over the sink as a secondary tap or on an optional font.

Touch-Free Wave



Featured product

HydroTap Touch-Free Wave in Chrome
installed over the sink as the secondary tap

To reduce shared touchpoints, the HydroTap Touch-Free Wave provides a 100% touch-free solution to instantly dispense pure-tasting drinking water with a simple wave of the hand.



Available water options & finishes:

 FILTERED: BOILING CHILLED SPARKLING	 FILTERED: BOILING CHILLED	 FILTERED: CHILLED SPARKLING
--	--	--

	
CHROME	MATTE BLACK WITH CHROME ACCENTS

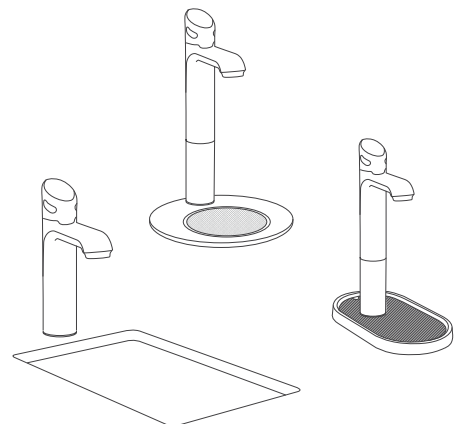

The Touch-Free Wave tap can be installed over the sink as a secondary tap or on an optional front

*The HydroTap Touch-Free Wave in Matte Black is available with our BCS and BC model only.

The safe and sustainable choice

Sitting beneath a sleek and stylish tap, our HydroTap command center houses the latest in advanced energy-efficient technology.

1 MILLION plastic bottles are purchased globally every **MINUTE**. More than **2/3** ending up in **landfills and our oceans**.*



Eliminates the need for bottled water
reducing your environmental impact

World class environmental credentials
providing transparent product lifecycle impact

Advanced energy management system
reduces power consumption by up to 30%

Utilizes air-cooled technology
making HydroTap 100% water efficient

* <https://www.beyondplastics.org/fact-sheets/plastic-water-bottles>

Maintenance, warranty and aftercare

It's important to perform routine maintenance on your HydroTap to keep it running at peak performance. This includes changing the filter at least once per year (or every 1,100 gallons/4,163 litres) and monitoring your CO₂ levels for our BCS and CS models.

To make it easy, Zip Water offers installation, preventative maintenance programs (including filter & CO₂ changes) and warranty repairs provided by our own certified technicians and Zip Water trained third-party partners.*

What's more, your HydroTap system is backed by a comprehensive parts and labor warranty.



3
Year
Warranty
Parts and labor
Terms and conditions apply

*Available in most metro areas

Technical information

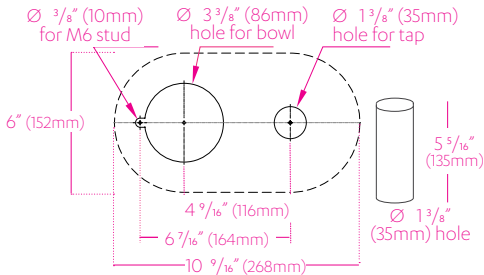
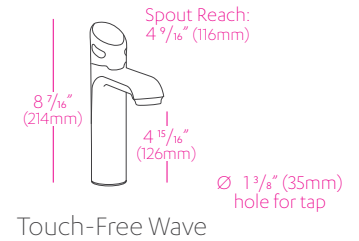
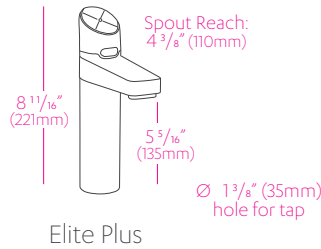
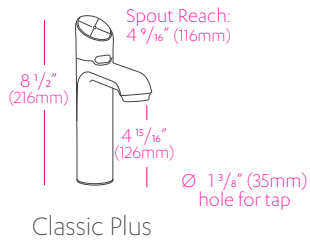
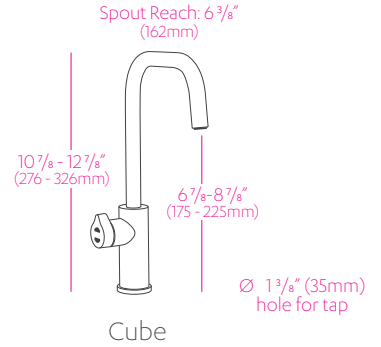
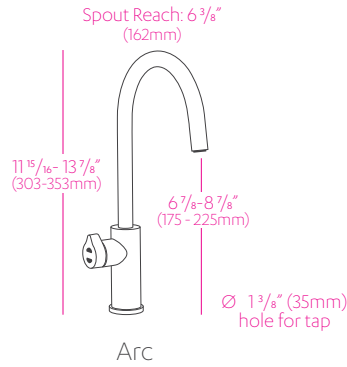
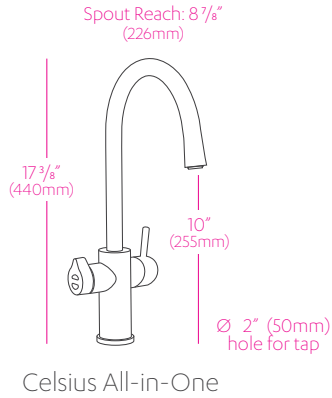

Classic Range Raised Font for Classic Plus, Elite Plus and Touch-Free Wave

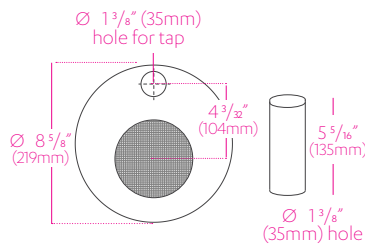

Classic Range Integrated Font for Classic Plus, Elite Plus and Touch-Free Wave

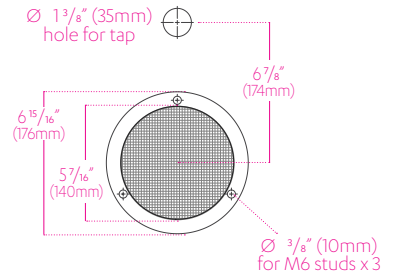

Stand Alone Design Range Font for Arc and Cube

BCS

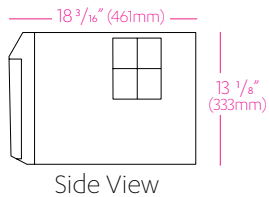
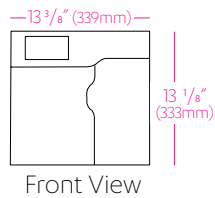

BC

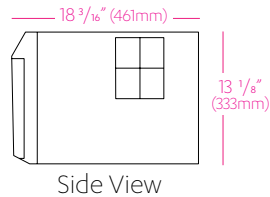
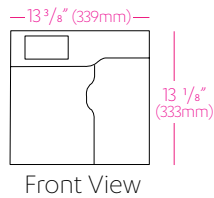

CS

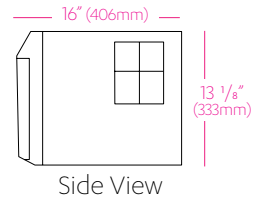
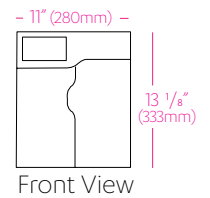

Installation requirements

Power: 1 x 110 – 120V, 50-60Hz, power supply with Nema 5-15 outlet

Water: 1 x ½" potable water supply

Water pressure: 37 – 100 psi / 2.60 - 7.03kg/cm² / 250-270kPa

Minimum flow rate: 1 gpm / 3.79 lpm

Optimal Total Dissolved Solids (TDS) range: 50ppm – 150ppm



Air Gap: Unit must have a minimum of 2" (50mm) clearance on left and right side and 8" (200mm) above

For full installation details including detailed spec sheets, visit na.zipwater.com or email wecare@na.zipwater.com for support.

Notes



HYDROTAP | FILTERED | INSTANT | **BOILING** | CHILLED | SPARKLING



na.zipwater.com

Toll-free number - North America +1 (833) 233 2358 | Email - wecare@na.zipwater.com

© 2023 Zip Water. All Rights Reserved.